

# twilight

INSTRUMENTOS DE MEDICIÓN INDUSTRIAL

## Medidor de Índice de Fluides XNR400E Laryee LY-XNR400E

[www.twilight.mx](http://www.twilight.mx)

 / [twilightsadecv](#)

 / [twilightsadecv](#)

 / [twilightsadecv](#)

## Content

1. Operating Principle.....	1
2. Technical Parameters.....	1
3. Structure.....	2
4. Installation and Adjustment.....	3
5. Instrument Operation and display.....	3
6. Operation.....	6
7. Caution .....	7
8. Appendix .....	7

According to the Standard of ISO1133,ASTM1238,ASTM3364, XNR-400E is used to test under the high temperature, measure the melt mass-flow rate (MFR) and the melt volume-flow rate (MVR) of thermoplastic, such as polyethylene, polystyrene, polypropylene, ABS resin, melt formaldehyde resin, polycarbonate, nylon, fluorine plastic, and fragrant sulphone. The machine automatically control the temperature and display the temperature and the time on a build-in digital screen. Three types of incision-techniques including manual, automatic, time controlled are used by the series of testers. It can automatically print out all the required experimental data. Specifically, and it have an option to perform MVR Test based on the new standard.

## 1. Operating Principle

XNR-400E is a plastic extruder. It works under the specified temperature to melt the sample by using heating furnace. The melted sample flows out a specified hole under the given load. In plastic producing activities, we usually use the melting index to, under melted state, measure the physical properties of the polymer, such as the fluidity, the mucosity and so on. The mass-flow rate **MFR** is the average mass of substance which passes through a given surface per 10 minutes. The unit is (**g/10min**), Denoted by **MFR**, which is defined as

$$\text{MFR} = 600 \times m \div t \quad (1)$$

Where

**MFR** The melt mass-flow rate of material, unit **g/10min**;

**m** Average mass, unit **g**;

**t** Time interval, unit **s**;

**600** Reference time (10 min), unit **s**.

### MFR Example

There is a group of plastic samples which are cutted per 30 seconds. The weights are 0.0838 g, 0.0862 g, 0.0815 g, 0.0895 g, 0.0825 g respectively.

The average weight,  $m = (0.0838 + 0.0862 + 0.0815 + 0.0895 + 0.0825) \div 5 = 0.0847$  g

Substituting into the equation, we have

$$\text{MFR} = 600 \times m \div 30 = 1.694(\text{g}/10\text{min}),$$

So that the MFR is 1.694g/10min.

## 2. Technical Parameters

### 2.1 Specification of the specimen extruder

2.1.1 Inner diameter of the mold **Φ2.095±0.005mm**

2.1.2 Length of the mold **8.000±0.025mm**

2.1.3 Inner diameter of the feeder **Φ9.550±0.025mm**

2.1.4 Length of the feeder **160mm**

2.1.5 Diameter of the head of piston rod **Φ9.475±0.015mm**

2.1.6 Length of the head of piston rod **6.350±0.100mm**

## 2.2 Specification of load

There are 8 Standard test resolution levels loading upon the incremental method.

### 2.2.1. Level 1

$$0.325\text{kg}=(\text{piston rod} + \text{adiabatic cover} + 1\#\text{weight})\text{kg}=3.187\text{N}$$

### 2.2.2. Level 2

$$1.200\text{kg}=(\text{level 1} + 2\#0.875\text{weight})\text{kg}=11.77\text{N}$$

### 2.2.3. Level 3

$$2.160\text{kg}=(\text{level 2} + 3\#0.960\text{weight})\text{kg}=21.18\text{N}$$

### 2.2.4. Level 4

$$3.800=(\text{level 3} + 4\#1.640\text{weight})\text{kg}=37.26\text{N}$$

### 2.2.5. Level 5

$$5.000\text{kg}=(\text{level 4} + 5\#1.200\text{weight})\text{kg}=49.03\text{N}$$

### 2.2.6. Level 6

$$10.000\text{kg}=(\text{level 5} + 6\#5.000\text{weight})\text{kg}=98.07\text{N}$$

### 2.2.7 Level 7

$$12.500\text{kg}=(\text{level 6} + 7\#5.000\text{weight})\text{kg}=98.07\text{N}$$

### 2.2.7 Level 8

$$21.6000\text{kg}=(\text{level 7} + 8\#2.500 + 8\#4.100 + 9\#5.000\text{weight})\text{kg}=211.82\text{N}$$

## 2.3 Temperature Range

**Set the temperature randomly in the range of 60.0°C to 400.0°C**

2.3.1 Reach the specified temperature in a moment by using PID.

2.3.2 Resolution of the temperature display 0.01°C

2.3.3 Digital time display, minimum unit 0.1 second.

2.4 Heating power:550W

2.5 Temperature Fluctuation

Fluctuation at the 10mm position of upper end  $\leq \pm 0.5^\circ\text{C}$  (60 to 250°C)

Fluctuation at the 10mm position of upper end  $\leq \pm 1^\circ\text{C}$  (250 to 450°C)

2.6 Power 220V  $\pm 10\%$ , 50Hz

2.7 Dimension 280mm  $\times$  350mm  $\times$  600mm

2.8 Weight about 28kg (Not include the weights)

### 3. Structure

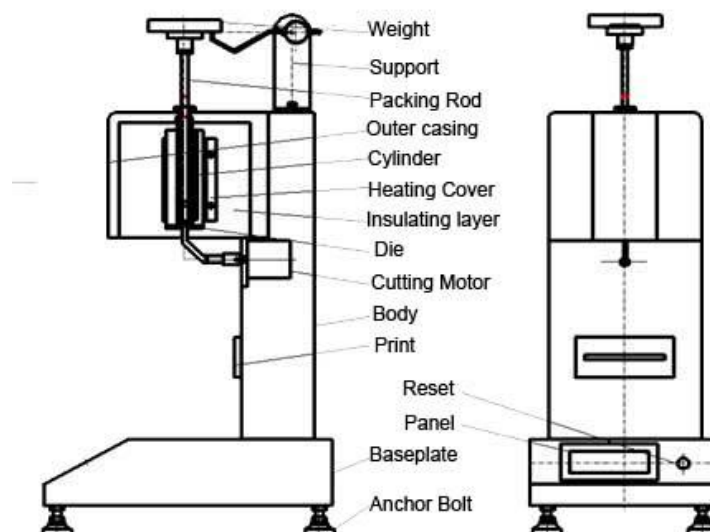

### 4. Installation and Adjustment

#### 4.1 Installation

XNR-400E melt flow index apparatus should be installed in the lab that has no dust, no vibration, no strong magnetic field and no strong disturbing signal. Place the tester on the workbench. Put the bubble into the feeder and observe it. Adjust the foot to make the tester to be horizontal.

**Note!**

- 1. The horizontal adjustment is relate to the accuracy of the test. Before start daily test please adjust again.**
- 2. The adjustment should be done when the temperature of the feeder is less than 40 °C.Or else, the bubble of the level instrument may burst.**

#### 4.2 Adjustment

4.2.1 Before power on, adjust the scraper to make it just reach the mold by turning the scraper, and then turn it to the position that it won't shield the extruder.

##### 4.2.2 Installation and uninstillation of the Mold

Put the mold into the feeder and make it down to the bottom. Use the bolt to poke it out.

##### 4.2.3 Display

The left side of the panel is time control and the right side is temperature control.

4.2.4 Turn on the power, the machine start to heating. The temperature control display the current temperature of the feeder.

## 5. Instrument Operation and display

Press Power button to the following interface. Press “ENTER” into main interface.

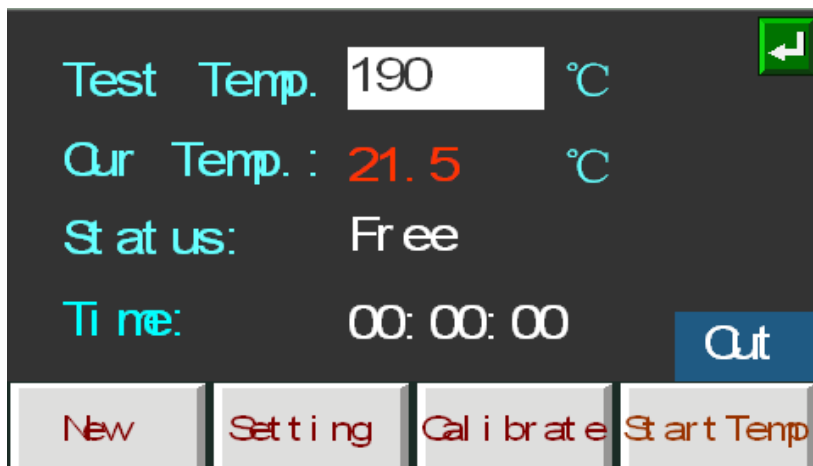
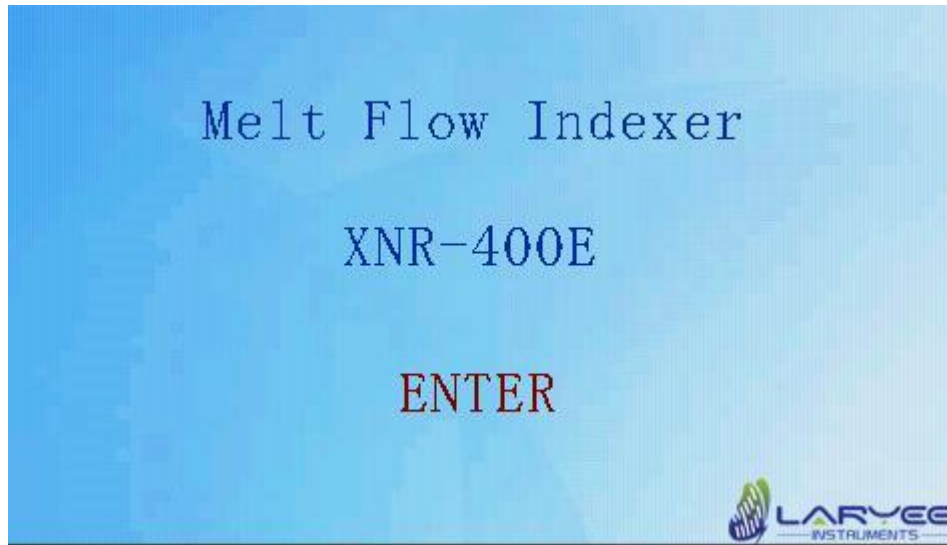

Press enter a new test;



Adjust the parameter. User do not need to change. If so, please contact the factory.

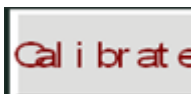

Adjust the parameter. User do not have the authority to enter.



Press this to start heating.



When the temperature become steady, press  , choose test method to the related interface. Enter the related data, when the travel stick down to the first scratch



press  to start the test.

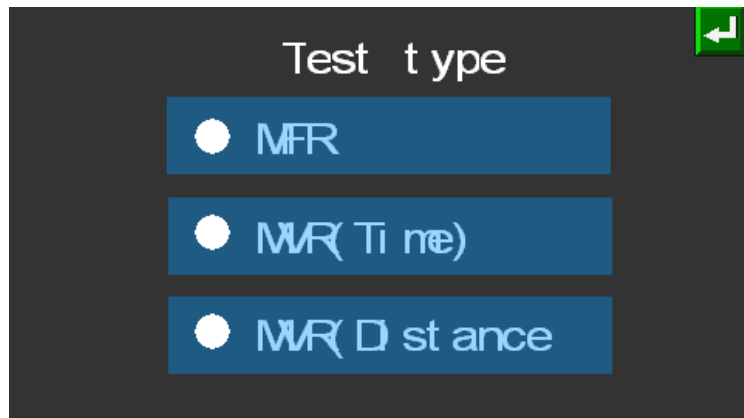

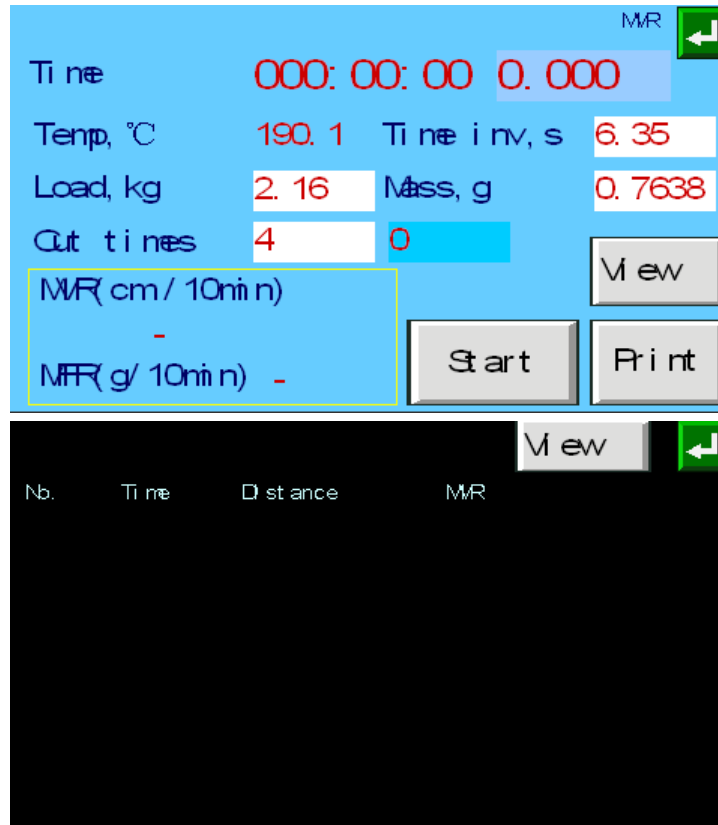

## 6. Operation

### 6.1 MFR control method

6.1.1 At this mode, use should set the cutting interval time and temperature first. Turn on heating switch and the furnace start heating to the set temperature. This may cost around 20 minutes.

6.1.2 Take out the piston when confirm the furnace temperature. Prepare around 4g sample by hopper. Press the sample and put in the piston. Set the time by certain standard or test method ( If no reference standard, set around 4 minutes ) , full load manually.

6.1.3 Extrude the melt to the lower reticule (Or judge by the extrude condition) , press



Time control cutting, The cut scraper rotate a circle and cut the front

extruded material. This part is the invalid. And then the cut scraper repeat cut the material by set time.

6.1.4 When the extruded melt reach the upper reticule (Or judge by the extrude

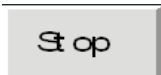
condition) ,press  to stop cutting. Collect the valid part. Usually is more



than 3 parts.

6.1.5 Use analyses balance weigh up the valid part and calculate the weight. Enter

Mass, g 0.7638

and

MFR, g/10min -

to display the result.

6.1.6 Use the bolt to take out the mould from the upper end. Clean the material feeder, scraper, mould discharge hole, mould and press stick.

**Note! User must clean the surface of the mould, piston and feeder by gauze. The mould dedicated hand drill push out the rest material when it is still hot, clean the mould to prepare the next test. Un-cleaned use method may bring incorrect test results.**

## 6.2 MVR test method

6.2.1 The test procedure is same with MFR. The only difference is start the cutting

material when the stick travels at the lower reticule to press

Start

and when the stick reach the upper reticule to press

Stop

to stop.

6.2.2 Weigh up the mass of the material between the upper and lower reticule. Substitute to the following formula.

$$\rho = m \div 0.716 \div 30$$

$\rho$  refers to the density (g/c m<sup>3</sup>) at certain temperature

$m$  refers to the mass of the material between the upper and lower reticule.

se agreement for English

## 7. Cautions

8.1 Single phase power must be reliably grounded.

8.2 After confirming the results, the instrument still at constant temperature, the tester can do the experiment continuously, re-input the parameters, too.

8.3. You should switching off the power if you don't need to use the instrument already.

8.4. The user can't uninstall the instrument optionally.

8.5. The instrument should be in the environment that has no strongly electromagnetic disturb.

8.6. The furnace chamber, the piston, the mouth mold should keep clean, no collision, no scoring, the furnace chamber can't be cleaned by the non-designated tools. After a period of usage, use high-level detergent to clean the outside of the furnace chamber and the piston.

8.7 The cleaning work is easy to be done under high temperature. But at the moment

please be more careful not to get burnt.

8.8. If the feeder, the piston rod or the mold has too much abrasion, the test result will be inaccurate. And you can order the parts in time from our company.

## **8. Appendix**

**1** Dry the specimens with kinds of shapes, such as grain, bar, slice and mould and so forth, before the test in accordance with the plastic type requirements. Weight the specimen referring to the Fig.a as following.

**Fig. a Weight of the specimen and time interval of incising**

<b>Velocity</b>	<b>Weight</b>	<b>Time interval</b>
( g/10min )	( g )	( s )
0.1 ~ 0.5	3 ~ 4	120 ~ 240
0.5 ~ 1.0	3 ~ 4	60 ~ 120
1.0 ~ 3.5	4 ~ 5	30 ~ 60
3.5 ~ 10	6 ~ 8	10 ~ 30
10 ~ 25	6 ~ 8	5 ~ 10

## **2 Conditioning**

Choose proper load, temperature and mold for the materials below according to Fig.b.

Polyethylene 1, 2, 3, 4, 6

POM 3

Polystyrene 4, 7, 11, 13

ABS 7, 9

Polypropylene 12, 14

Polycarbonate 16

Polyamide 10, 15

Acrylate 8, 11, 13

Cellulose acetate 2, 3

**Note!** Plastic belongs to copolymer blending modified PP may refer to the classification above.

**Fig.b Test Conditions**

No.	Inner diameter of standard mold, unit: mm	Temperature unit: °C	Coefficient of mold unit: g mm <sup>2</sup>	Load unit: kg
1	1.180	190	146.6	2.160
2	2.095	190	70	0.325
3	2.095	190	464	2.160

## XNR-400E Melt Flow Indexer operation manual

---

4	2.095	190	1073	5.000
5	2.095	190	2146	10.000
6	2.095	190	4635	21.600
7	2.095	200	1073	5.000
8	2.095	200	2146	10.000
9	2.095	220	2146	10.000
10	2.095	230	70	0.325
11	2.095	230	253	1.200
12	2.095	230	464	2.160
13	2.095	230	815	3.800
14	2.095	230	1073	5.000
15	2.095	275	70	0.325
16	2.095	300	253	1.200

### 3 Result of weighting

Cool the specimen after incising. Place the specimens on the balance (Requires a Analytical Balance with the precision of 0.001g) and weight them repectively.

Calculate the result according to the formula below:

$$\text{MFR}=600 \times W/t \quad (\text{g}/10\text{min})$$

Where:

MFR: Melt flow rate, unit: g/min

W: Average weight of specimens

t: Time interval of incising, unit: s

Take two decimal points after getting the test result.

**Note! Each specimen should be tested horizontally for two times and calculate the MFR value.**

**If the offset is beyond 10% between the two MFR values, find out the reason.**

# twilight

INSTRUMENTOS DE MEDICIÓN INDUSTRIAL



LLÁMANOS

+52(81) 8115-1400 / +52 (81) 8173-4300

LADA Sin Costo:  
01 800 087 43 75

E-mail:  
[ventas@twilight.mx](mailto:ventas@twilight.mx)

[www.twilight.mx](http://www.twilight.mx)



/ [twightsadecv](https://www.facebook.com/twightsadecv)



/ [twightsadecv](https://twitter.com/twightsadecv)



/ [twightsadecv](https://www.youtube.com/twightsadecv)